

# VIVE TP-S-755WHO

COMFORT

**Vive Comfort**

P.O. Box 3377  
 Springfield, MO 65808-3377  
 Toll Free : 888-776-1427  
 Web: www.vivecomfort.com  
 Hours of Operation: M-F 9AM - 6PM Eastern



**Thermostat Application Guide**

Description	
Gas or Oil Heat	Yes
Electric Furnace	Yes
Heat Pump (No Aux. or Emergency Heat)	Yes
Heat Pump (With Aux. or Emergency Heat)	Yes
Multi-Stage Systems	Yes
Heat Only Systems	Yes
Cool Only Systems	Yes
Millivolt	No
Humidity	Yes
Dual Fuel	Yes

**Power Type**

Battery Power\*  
 Hardwire (Common Wire)  
 Hardwire (Common Wire) with Battery Backup

**A trained, experienced technician must install this product.**

Carefully read these instructions. You could damage this product or cause a hazardous condition if you fail to follow these instructions.

Una version en español de este manual se puede descargar en la pagina web de la compañía.



**Table of Contents**

**Page**

Installation Tips	2-6
Private Label Badge	7
Thermostat Quick Reference	8-9
Wireless Communication Tips	10
Connecting To The PROsync	
Wireless System	11
Wiring The Equipment Module	12
Wiring	13-16
Benefits To Using The PROsync	
Wireless System	17-18
Technician Setup Menu	19-35
Setting the Humidity	36
Programming	37-42
Specifications	43-44

**Wall Locations**

The thermostat should be installed approximately 4 to 5 feet above the floor. Select an area with average temperature and good air circulation.

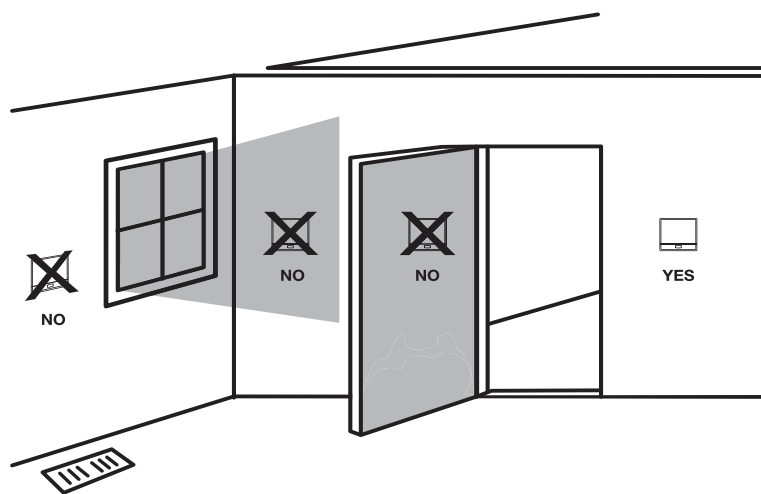

**Do not install thermostat in these locations:**

- Close to hot or cold air ducts
- That are in direct sunlight
- With an outside wall behind the thermostat
- In areas that do not require conditioning
- Where there are dead spots or drafts (in corners or behind doors)
- Where there might be concealed chimneys or pipes

**Installation Tip**

Pick an installation location that is easy for the user to access. The temperature of the location should be representative of the building.

**Installation Tips**

**Wireless Range**

The PROsync System has been tested in many different types of building construction including wood, steel beam, and brick in spaces over 5500 square feet. The wireless range performs well across multiple floors successfully. The PROsync radios constantly search for open channels to avoid interference and ensure messages are received. The PROsync system has been shown to reliably transmit data across hundreds of feet indoors and over 1000 feet line of sight.

**Equipment Module -Attic Location**

When performing an attic installation, instead of placing the equipment module in the attic, locate the closet nearest to the air conditioning unit. We recommend mounting the Equipment module high on the wall inside the closet or on the ceiling of the closet. This location will insure the equipment module is below the 150°F maximum ambient temperature specification while also allowing easy technician viewing.

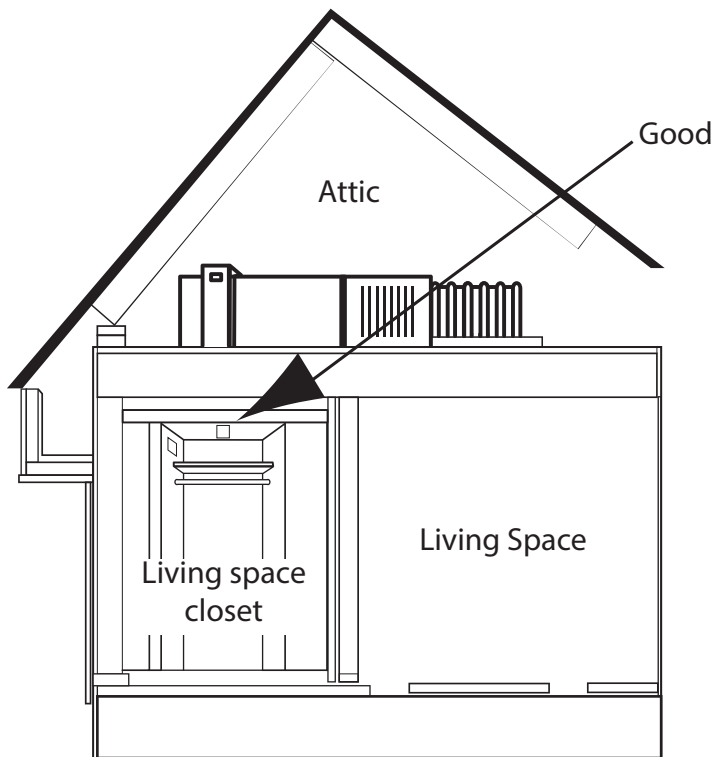

**Installation Tips**

**Equipment Module - Basement Location**

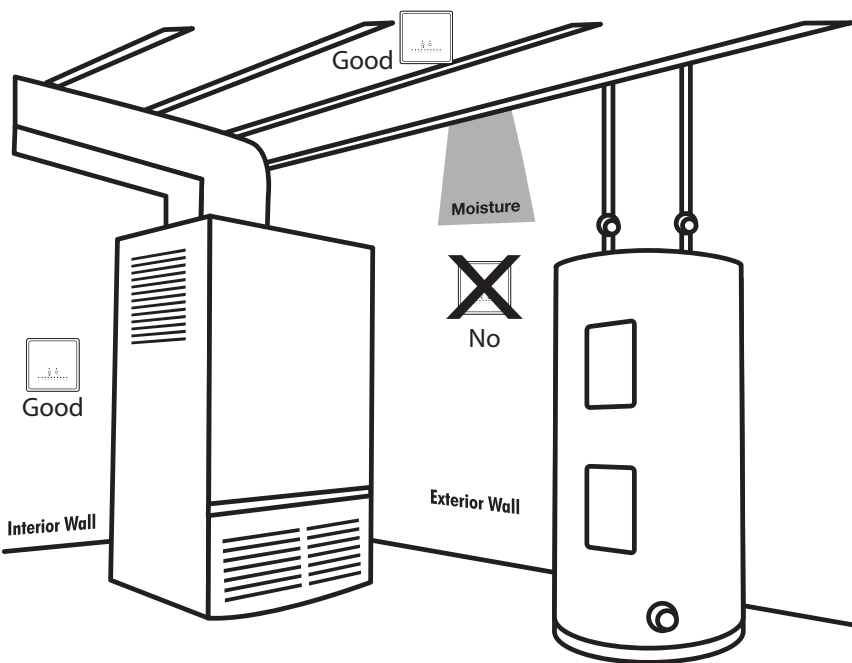

**Installation Tips**

**Do not install the base module in locations:**

- That are behind a chimney
- Where temperature could exceed 150°F
- Where rain or snow or extreme hot or cold is possible

**Note: This base module is NOT weatherproof.**

## Thermostat Subbase Installation

## Equipment Module Subbase Installation

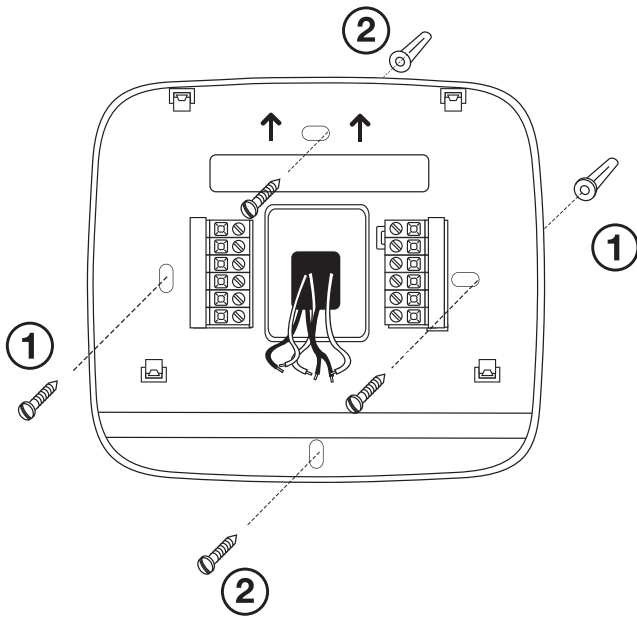

- 1** Horizontal Mount For horizontal mount put one screw on the left and one screw on the right.
- 2** Vertical Mount For vertical mount put one screw on the top and one screw on the bottom.

### Installation Tip: Electrical Hazard

Failure to disconnect the power before beginning to install this product can cause electrical shock or equipment damage.

### Mercury Notice

All of our products are mercury free. However, if the product you are replacing contains mercury, dispose of it properly. Your local waste management authority can give you instructions on recycling and proper disposal.

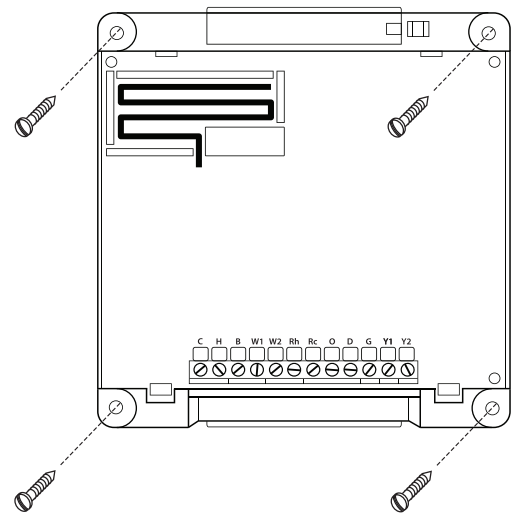

For the equipment module mount 4 screws in each outer hole.

### Wiring Note

Wire the equipment module's subbase the same way you would wire a hardwired thermostat subbase.

### Note:

To connect the equipment module to the master thermostat, refer to the directions on page 11 of this manual.

### Note:

The base module must be hardwired (C and R terminals connected to 24V power.)

5

6

## Thermostat Quick Reference

## Wireless Communication Setup

### Getting to know your thermostat

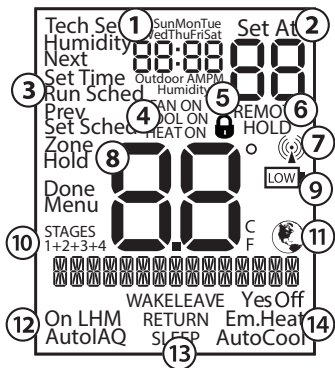

- 1 Time and day of the week**
- 2 Setpoint:** Displays the selected setpoint temperature.
- 3 Menu Options:** Shows different options.
- 4 System Operation Indicators:** The COOL ON, HEAT ON, or FAN ON will display when the COOL, HEAT, or FAN is on. **The compressor delay feature is active if these are flashing.**
- 5 Keypad Lockout:** Indicates keypad lockout state is "Locked".
- 6 Hold** is displayed when the thermostat program is permanently overridden.
- 7 Radio Antenna:** This icon blinks when the thermostat receives a message from the equipment module.
- 8 Indicates the current room temperature**
- 9 Low Battery Indicator:** Replace batteries when this indicator is shown.
- 10 Stages:** 1 will appear in the display when the first stage of heat or cool is on, +2 will appear for the second stage, +3 for third stage and +4 for fourth stage.
- 11 Globe:** Globe is displayed if an energy efficient temperature has been selected.
- 12 Fan Mode:** Indicates current air handler fan mode of operation.
- 13 Program Time Periods:** This thermostat has 4 programmable time periods per day.
- 14 System:** Indicates current mode of operation.

### Important

The low battery indicator is displayed when the AA battery power is low. Replace the batteries when the indicator appears. If the system is in the low battery state for an extended period, the system will operate with reduced temperature control. If battery power is lost, the system will cease operation even if the equipment module is still connected.

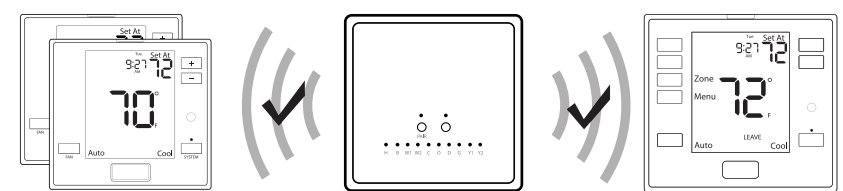

### Follow these steps to setup the PROsync Wireless System

1. Choose the equipment module location.
2. Remove the front cover and attach the equipment module to the wall.
3. Wire the equipment module to the air handler.
4. Snap the cover back on. The C terminal light should be illuminated indicating the equipment module is powered.
5. Install batteries in the main thermostat and ensure it is communicating with the equipment module. Any changes to the main thermostat that create a call will now be displayed at the equipment module in the LEDs associated with the terminals.
6. Choose the install location for the T755WHO. In the tech settings, check the "Signal Strength" tech setting and ensure the value is greater than zero.
7. Remove the subbase and attach it to the wall using screws and anchors in the box.
8. If you want to hardwire the thermostat, connect the R and C wires.
9. Snap the thermostat onto the subbase. Make sure the connection is secure and the display is illuminated.
10. Add any additional remote sensors as desired.

### Note.

Each time a message goes back and forth between the remote thermostat and the equipment module, the light on the equipment module will blink blue twice, and the antenna icon on the remote will blink twice.

9

10

About The Badge

All of our thermostats use the same universal magnetic badge. Visit the company website to learn more about our free private label program.

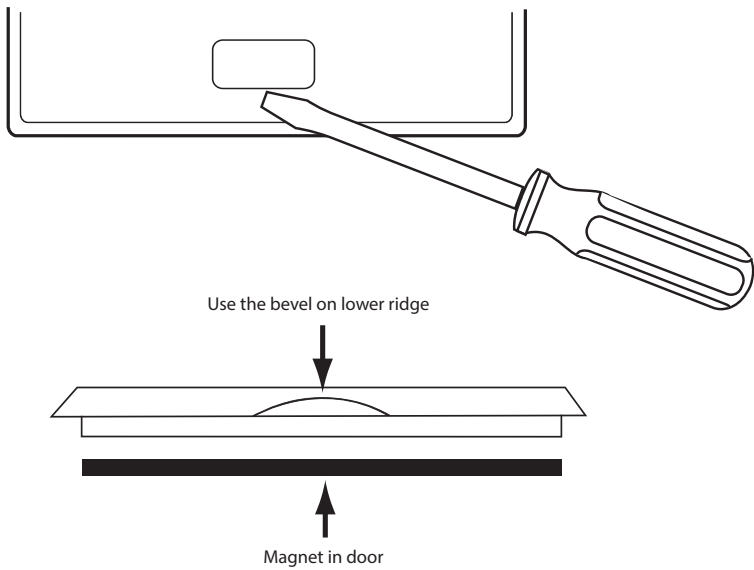

Gently slide a screwdriver into the bottom edge of the badge. Gently turn the screwdriver counter clockwise. The badge is held on by a magnet in the well of the battery door. The badge should pry off easily. **DO NOT USE FORCE.**

Getting to know your thermostat

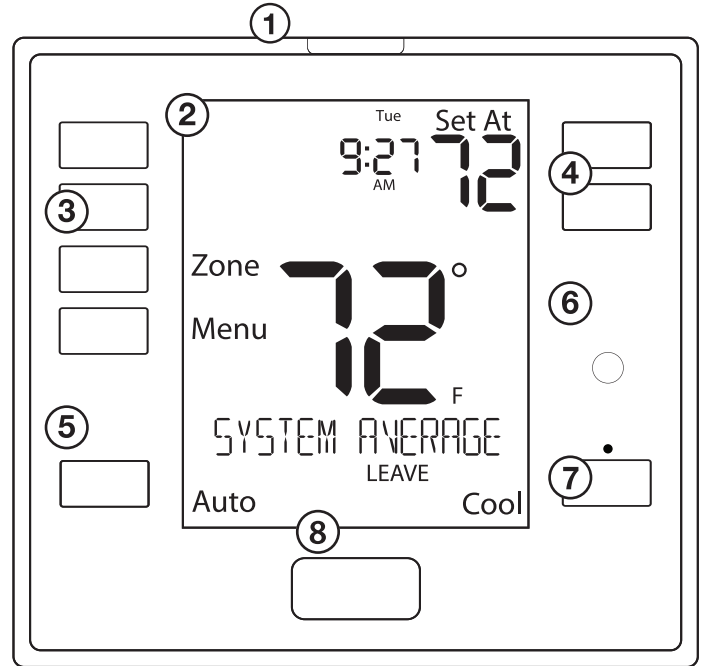

- ① Glow in the dark light button
- ② LCD Display
- ③ User Buttons
- ④ Temperature Setpoint Buttons
- ⑤ Fan Button
- ⑥ Occupancy Sensor
- ⑦ System Button
- ⑧ Private Label Badge

Adding A Remote Sensor

Establishing communication between a remote sensor and the equipment module

The main thermostat and equipment module in this package are linked at our factory. Upon power up, they will automatically begin to communicate. If you wish to add additional remote sensors, follow the instructions on this page.

How To Pair

1. Press the PAIR button on the equipment module. The equipment module will begin double blinking pink for 2 minutes while it listens for a new remote.
2. Press and hold the light button on the unpaired remote sensor to be added. The remote sensor will show "PAIRING" on the main screen.
3. When the remote sensor is successfully paired to the equipment module, the LCD will display "PAIRED" and the equipment module Pair button LED will blink green.
4. Repeat the process for additional remote sensors.

Network Troubleshooting

For any of the conditions listed below, please visit our website for troubleshooting instructions at [www.pro1iaq.com/prosync](http://www.pro1iaq.com/prosync)

If your remote shows "NO COMM TO BASE" in the text field, this indicates the remote thermostat cannot communicate with the equipment module.

Equipment Module Troubleshooting

Light Color	Blinking Type	Description
White	Single Blink (slow)	Equipment module network reset - no remotes paired or connected. Equipment module will not energize the heating and cooling system.
Green	Single Blink	All remote thermostats are connected to the equipment module, network is healthy.
Yellow	Double Blink	One or more remote thermostats are disconnected from the equipment module.
Red	Triple Blink	All remote thermostats are disconnected. Equipment module will not energize the heating and cooling system.

Wiring For The Equipment Module



Caution: Electrical Hazard

Failure to disconnect the power before beginning to install this product can cause electrical shock or equipment damage.



Warning:

All components of the control system and the thermostat installation must conform to Class II circuits per the NEC Code.

Wiring

1. If you are replacing a thermostat, make note of the terminal connections on the thermostat that is being replaced. In some cases the wiring connections will not be color coded. For example, the green wire may not be connected to the G terminal.
2. Loosen the terminal block screws. Insert wires then retighten the terminal block screws.
3. Place nonflammable insulation into the wall opening to prevent drafts.



Installation Tip

Do not overtighten terminal block screws, as this can damage the terminal block. A damaged terminal block can keep the thermostat from fitting on the subbase correctly or cause system operation issues.

**Max Torque = 6in-lbs.**

Wiring Tips

C Terminal

The C (common wire) terminal does not have to be connected when the thermostat is powered by batteries.

Note:

In many heat pump systems with no emergency heat relay, a jumper can be installed between W1 and W2 to turn thermostat into a single stage control for Emergency Heat Operation.

Wire Specifications

Use shielded or non-shielded 18-22 gauge thermostat wire.

**Terminal Designations on the Equipment Module**

This thermostat is shipped from the factory to operate a conventional heating and cooling system. This thermostat may also be configured for a heat pump system. See the "heat pump" configuration step on page 16 of this manual to configure the thermostat for heat pump applications.

Terminal	2 Heat 2 Cool Conventional System	2 Heat 2 Cool Heat Pump System	4 Heat 2 Cool Heat Pump System
RC	Transformer power (cooling)	Transformer power (cooling)	Transformer power (cooling)
RH	Transformer power (heating)	Transformer power (heating)	Transformer power (heating)
C	Transformer common	Transformer common	Transformer common
B	Energized in heating	Heat pump changeover valve energized in heating	Heat pump changeover valve energized in heating
O	Energized in cooling	Heat pump changeover valve energized in cooling	Heat pump changeover valve energized in cooling
G	Fan relay	Fan relay	Fan relay
W1	First stage of heat	First stage of emergency heat	First stage of emergency heat, third stage of heat
Y	First stage of cool	First stage of heat & cool	First stage of heat & cool
Y2	Second stage of cool	Second stage of cool	Second stage of cool & second stage of heat
W2	Second stage of heat	Auxiliary heat relay, second stage of heat	Auxiliary heat relay, fourth stage of emergency heat
H	Humidify	Humidify	Humidify
D	Dehumidify	Dehumidify	Dehumidify

**Terminal Designations on the Master Thermostat**

Terminal	2 Heat 2 Cool Conventional System	2 Heat 2 Cool Heat Pump System	4 Heat 2 Cool Heat Pump System
R	24 VAC transformer power	24 VAC transformer power	24 VAC transformer power
C	transformer common	transformer common	transformer common

**Wiring Tips**

- 1 Power supply
- 2 Factory - installed jumper. Remove only when installing on a 2 transformer systems.
- 3 Use either O or B terminals for changeover valve.
- 4 Optional 24 VAC common connection when thermostat is used in battery power mode.

**Typical 2H/2C System: 1 Transformer**

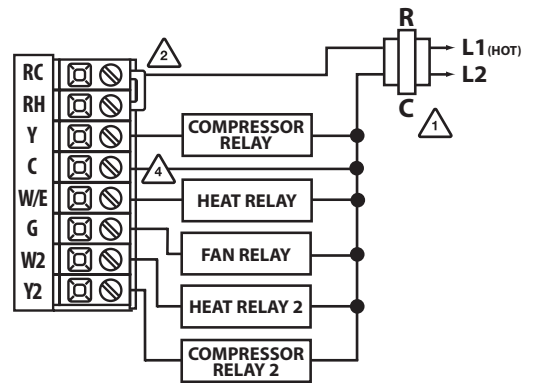

**Benefits To Using The PROsync Wireless System**

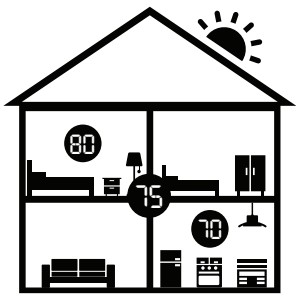

When using remote sensing, this system can be configured four separate ways to maximize comfort for homeowner and cater to each of their unique lifestyles.

**System Averaging**

System Averaging will average all remotes together to provide a more accurate temperature of the entire home. Adjusting the temperature from any remote will temporarily put that room in control of the system. If the upstairs thermostat reads 80 while the basement reads 70 the system will condition the home to a 75 ambient.

**Scheduling**

With scheduling the system you can make different rooms in control for each part of the day. For homeowners with predictable schedules, this ensures each room will be the target temperature when scheduled to be used. Making the kitchen in control in the morning, your home office during the day, your living room in the evening, and your master bedroom at night is a great hands-free approach to maximize comfort. To turn Scheduling on or off, see the instructions for the "Program Mode" tech setting in this manual on page 22.

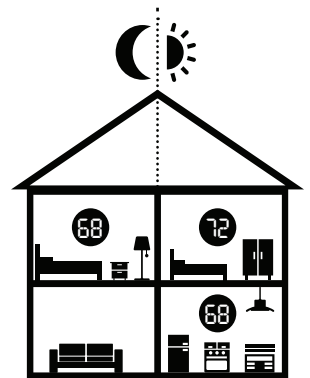

**Occupancy Sensing (Last Seen Mode)**

This is the perfect solution for homes with a single occupant with less predictable schedules, using the built-in occupancy sensors moves the comfort around the home without the need for scheduling. As soon as someone enters a room, it takes control of the system. To turn Last Seen Occupancy Sensing on, see the instructions for "Occupancy Mode" tech setting in this manual on page 31.

**Occupancy Sensing (System Average Mode)**

This is an excellent solution for a home with multiple occupants. Each time a remote senses occupancy, it starts an automatic, internal timer. The system is controlled using the average of the temperatures from only the remotes with active timers. When a remote's timer expires, the system removes that remote from the average. To turn System Average Occupancy Sensing on, see the instructions for "Occupancy Mode" tech setting in this manual on page 31.







**Note:** This thermostat is hardwire powered when the 24V transformer is connected to the **R and C** terminals of the thermostat.



**Note:** In many systems with no emergency heat relay a jumper can be used between W1 and W2.

**Typical Cool-Only System With Fan**

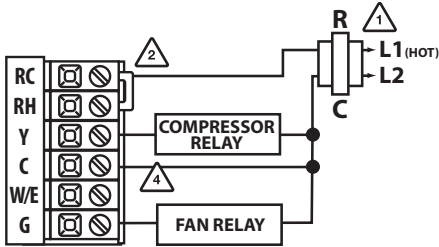

**Typical Heat Only System With Fan**

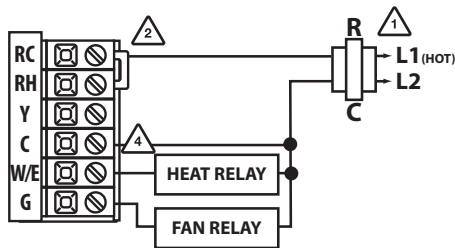

**Typical 2H/2C System: 2 Transformer**

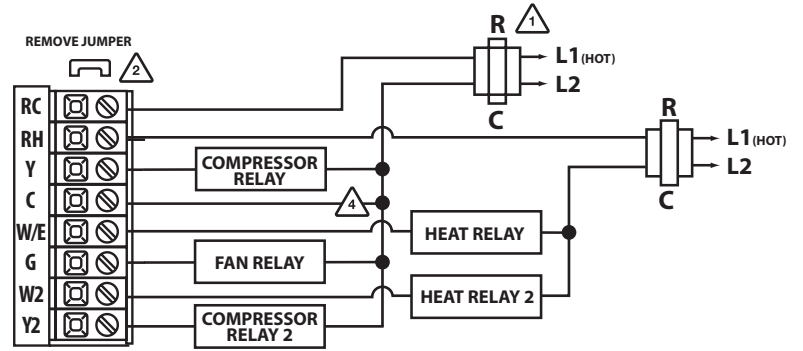

**Typical 2H/1C Heat Pump System**

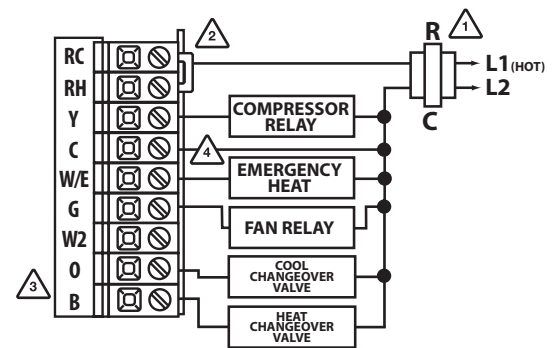

**Technician Setup**

This thermostat has a technician setup menu for easy installer configuration. To set up the thermostat for your particular application:

1. Press the **MENU** button.
2. Press and hold the technician setup button for 3 seconds. This 3 second delay is designed so that homeowners do not accidentally access the installer settings.
3. Configure the installer options as desired using the table below.

Use the **-** or **+** keys to change settings and the **NEXT** step or **PREVIOUS** step key to move from one step to another.

**Note:** Only press the **DONE** key when you want to exit the Technician Setup options.

4. Press the **DONE** key to exit.

Tech Setup Steps	LCD Will Show	Adjustment Options	Default
Filter Change Reminder	OFF FILTER 0	You can adjust the filter change reminder from "OFF" to 2000 hours of fan runtime in 50 hour increments.	OFF
Room Temperature Calibration	0 CALIBRATE	You can adjust the room temperature display to read up to 4° above or below the factory calibrated reading.	0°F
Cooling Swing	0.5 COOL SWING	The cooling swing setting is adjustable from 0.2° to 2°. For example: A swing setting of 0.5° will turn the cooling on at approximately 0.5° above the setpoint and turn the cooling off at approximately 0.5° below the setpoint.	0.5°
Heating Swing	0.8 HEAT SWING	The heating swing setting is adjustable from 0.2° to 2°. For example: A swing setting of 0.5° will turn the heating on at approximately 0.5° below the setpoint and turn the heating off at 0.5° above the setpoint.	0.8°

**Technician Setup**

Tech Setup Steps	LCD Will Show	Adjustment Options	Default
PTAC Mode	OF PTAC MODE	This setting allows the thermostat to operate a PTAC. This will allow for multiple fan speeds selectable in the next two tech settings.	OFF
PTAC Fan Speeds <small>(Only displayed if PTAC mode is set to "ON")</small>	2 PTAC FAN SPEEDS	This setting allows you to choose the number of fan speeds the thermostat will control. G = Low Speed Fan B/O = Medium Speed Fan Y2 = High Speed Fan	2
PTAC Medium Fan Speed Terminal <small>(Only displayed if PTAC mode is set to "ON" and PTAC fan speeds is set to "3")</small>	0 M FAN TERMINAL	This setting will select the terminal for medium fan speed operations. The selected terminal cannot be used for reversing valve operations when heat pump is enabled.	0
Heat Pump	OF HEAT PUMP	When turned on the thermostat will operate a heat pump. EM. Heat will show as an option in the system switch tech setting. Use the <b>+</b> and <b>-</b> button to adjust.	OFF
System Set	SYSTEM SET Off Heat Cool	You can configure the system switch for the particular application. Heat - Off - Cool, Heat - Off, Cool - Off, Heat - Off - Cool - Auto. Note: Emergency Heat is available in heat pump mode only.	Heat Off Cool

**A Note About Auto Changeover:**

In Auto you have the ability to switch between Auto Heat or Auto Cool by pressing the system key. This can be done once the current mode has reached its setpoint. For example: if in Auto Heat, the heat setpoint must be satisfied before the thermostat will allow you to switch to Auto Cool. You can switch out of Auto by holding down the **SYSTEM** key. To get back into Auto, you must toggle the system key to Auto.

Tech Setup Steps	LCD Will Show	Adjustment Options	Default
<b>Dual Fuel Auxiliary For Heat Pump</b> (Only displayed if heat pump is set to "ON")		Use the <b>[+]</b> and <b>[-]</b> buttons to select ON/OFF.	OFF
<b>Electric or Gas Fan Operation</b> Note: If heat pump is set to "ON" this step will not show, and will default to ELECTRIC.		Use <b>[+]</b> and <b>[-]</b> buttons to change the setting.	GAS
<b>System Stages</b>		Use the <b>[+]</b> and <b>[-]</b> buttons to select 1H/1C, 1H/2C, 2H/1C, 2H/2C, 3H/1C, 3H/2C, 4H/2C. Note: Heat and cool choices are limited based on conventional, heat pump, or PTAC system configuration.	2H
<b>Satisfy Setpoint Staging</b> (Only displayed if there are more than one stage of heat or cool)		Use the <b>[+]</b> or <b>[-]</b> buttons to turn on of off.	OFF
<b>Staging Delay</b> (Only displayed if there are more than one stage of heat or cool)		Use the <b>[+]</b> or <b>[-]</b> key to select OFF, 5, 10, 15, 30, 45, 60, or 90 minutes.	OFF

Tech Setup Steps	LCD Will Show	Adjustment Options	Default
<b>Minimum Compressor On Time</b>		You can set the minimum compressor run time to "OFF", "3", "4", or "5" minutes. If 3, 4 or 5 is selected, the compressor will run for at least the selected time before turning off. Use the <b>[+]</b> and <b>[-]</b> buttons to change the setting.	OFF
<b>Compressor Short Cycle Delay</b>		Selecting "ON" will not allow the compressor to be turned on for 5 minutes after the last time the compressor was on. Select "OFF" to remove this delay. Use the <b>[+]</b> and <b>[-]</b> buttons to change the setting.	ON
<b>Cooling Fan Delay</b>		The cooling fan delay setting will delay the fan from coming on in cool mode and keep it running after the compressor shuts off for a short time to save energy in some systems.	OFF
<b>Program Options</b>		You can configure this thermostat to have a 7 day program, a 5+1+1 program or No program. Note: If 7d is selected, in set schedule you will program all seven days individually. If 5d is selected, in set schedule you will program Monday – Friday together and Saturday and Sunday individually. If 0d is selected the thermostat becomes non-programmable and the Set Schedule button goes away in Menu.	5d

Tech Setup Steps	LCD Will Show	Adjustment Options	Default
<b>IAQ Mode Cycle</b> Notes: This programmable/selectable mode will operate the fan 1-4 cycles per hour, 1-45 minutes per cycle. Once programmed in tech setup, to enable this mode select "IAQ" with the fan key. Disable this mode by selecting "ON" or "AUTO" with the fan key.		Select OFF, 1, 2, 3 or 4 with the <b>[+]</b> or <b>[-]</b> buttons. This sets the number of cycles per hour that the IAQ fan mode will operate.	0
<b>IAQ Minutes Per Cycle</b> (Only displayed if "IAQ Mode Cycle" is greater than 0)		Select 1, 5, 10, 15, 20, 30 or 45 minutes. When IAQ fan mode is enabled, it will ensure the fan runs at least the selected number of minutes per IAQ Mode Cycle. This step will not appear if previous step is set to "OFF".	1

Tech Setup Steps	LCD Will Show	Adjustment Options	Default
<b>Fresh Air Mode</b> (This setting cannot be used with PTAC)		Use the <b>[+]</b> and <b>[-]</b> buttons to select OFF, OC ON or ON.  OFF: Thermostat does not enable Fresh Air Mode.  OC ON: Fresh Air Mode is enabled during the OCCUPIED, WAKE, RETURN, and SLEEP time periods (It will not bring in fresh air during UNOCCUPIED and LEAVE time periods).  ON: Thermostat will enable Fresh Air Mode for every time periods.	OFF
<b>Fresh Air Terminal</b> (Only displayed if fresh air mode is turned ON. This setting cannot be used with PTAC, three stages of cool, or economizer turned ON)		This setting provides the option to select a terminal for Fresh Air damper functions. The selected terminal cannot be used for reversing valve operations when the heat pump setting is turned on.	0
<b>Fresh Air Minutes</b>		This setting selects the minimum number of minutes that the fresh air damper will be energized.	5
<b>Free Cooling</b> (Only displayed if an outdoor remote sensor is paired to the equipment module)		This feature will bring in outside air for first stage cooling operations, if the outdoor temperature is 5 (or more) degrees lower than the setpoint temperature. This setting can only be enabled if the thermostat is in cooling mode.	OFF

## Technician Setup

Tech Setup Steps	LCD Will Show	Adjustment Options	Default
<b>Pro Recovery</b> (Only displayed if Program Option is set to "5D" or "7D" or if Occupancy Control is set to "ON")		Use the $\oplus$ or $\ominus$ key to select on or off.	ON
<b>Cycle Minimizer</b> (Only displayed if Program Option is set to "5D" or "7D" or if Occupancy Control is set to "ON")		Use the $\oplus$ or $\ominus$ key to select on or off.	OFF
<b>Keypad Lockout</b> Note: Unlike other models, keypad lockout is always engaged if it is set to PARTIAL or FULL.		Use the $\oplus$ and $\ominus$ buttons to select OFF, BASIC, PART, FULL OF - OFF= keypad lockout has been disabled. BA - BASIC= locks out menu PA - PARTIAL= partial keypad lockout, which locks all the keys except the or setpoint keys. FL - FULL= full keypad lockout, which locks out all the keys.	OFF
<b>Heat Setpoint Limit</b>		Use the $\oplus$ or $\ominus$ key to select the maximum heat setpoint.	90°F
<b>Cool Setpoint Limit</b>		Use the $\oplus$ or $\ominus$ key to select the minimum cooling setpoint.	44°F

23

## Technician Setup

Tech Setup Steps	LCD Will Show	Adjustment Options	Default
°F or °C		Use the $\oplus$ or $\ominus$ key to select °F for Fahrenheit or °C for Celsius.	°F
12 or 24 Hour Clock		You can select either a 12 or 24 hour clock setting.	12
<b>Display Light</b> (This setting is only applied when the thermostat is hardwired)		Use the $\oplus$ and $\ominus$ buttons to select OFF, LOW, or HIGH. OFF configures the display light to come on when the light key or any button is pressed. LOW configures the display light to stay on at a low intensity constantly. When a button is pressed, the display light will transition to high intensity. HIGH configures the display light to remain on at high intensity all the time.	LO When Hardwired

24

## Technician Setup

Tech Setup Steps	LCD Will Show	Adjustment Options	Default
<b>Free Cooling Terminal</b> (Fresh air mode and free cooling can be used together. Free cooling cannot be used with PTAC mode, three stages of heat.)		Use the $\oplus$ and $\ominus$ buttons to select 0/B.	0
<b>Dual Fuel Balance Point</b> (Only displayed if an outdoor remote sensor is paired to the equipment module, Heat Pump is "ON", and Dual Fuel Aux is "ON")		Use the $\oplus$ and $\ominus$ buttons to select OFF, 10, 15, 20, 25, 30, 35, 40, 45, 50 degrees.	OFF
<b>Balance Point Electric AUX Cut In</b> (Only displayed if an outdoor remote sensor is paired to the equipment module, Heat Pump is "ON", and Dual Fuel Aux is "OF")		Use the $\oplus$ and $\ominus$ buttons to select 10, 15, 20, 25, 30, 35, 40, 45, 50 degrees.	OFF





27



## Technician Setup

Tech Setup Steps	LCD Will Show	Adjustment Options	Default
<b>Balance Point Electric AUX Cut Out</b> (Only displayed if an outdoor remote sensor is paired to the equipment module, Heat Pump is "ON", and Dual Fuel Aux is "OF")		Use the $\oplus$ and $\ominus$ buttons to select 10, 15, 20, 25, 30, 35, 40, 45, 50 degrees.	OFF
<b>Balance Point Run Time</b> (Only displayed if Dual Fuel Balance Point or Balance Point Electric Aux Cut In are set to an outdoor temperature.)		Off, 15, 30, 45, 60, 75, 90	OFF
<b>Humidify</b>		This feature adds humidity when the system mode is in HEAT. Use the $\oplus$ and $\ominus$ key to turn on or off. If ON is selected the humidity will be displayed on the main screen and H terminal will energize when the humidity setpoint is above the ambient humidity in Heat mode.	OFF
<b>Dehumidify</b>		This feature removes humidity when the system mode is in COOL. Use the $\oplus$ and $\ominus$ key to turn on or off. If ON is selected the humidity will be displayed on the main screen and D terminal will energize when the humidity setpoint is below the ambient humidity in Cool mode.	OFF

28



Tech Setup Steps	LCD Will Show	Adjustment Options	Default
<b>Humidity Calibration</b> (Only displayed if Humidify or Dehumidify is set to "ON")		Use the left and right arrows to adjust the calibration +/-3. Each one unit of adjustment amounts to approximately 5%.	0
<b>Automatic Humidity Adjusting</b> (Only displayed if an outdoor remote sensor is paired to the equipment module and Humidity is set to "ON")		Use the $\left[ \rightarrow \right]$ and $\left[ \leftarrow \right]$ buttons to select OFF, ON 1 or ON 2. When ON 1 or ON 2 is selected and humidity level is adjusted, the thermostat will revert to the original humidity level after four hours. See Automatic Humidity Adjusting chart for humidity ranges.  Please see page 32 for chart.	OFF
<b>Dehumidify With AC</b> (Only shows if dehumidify is displayed to "ON")		Use the $\left[ \rightarrow \right]$ and $\left[ \leftarrow \right]$ buttons to select On or Off.	OFF
<b>Over Cool Limit</b> (Only displayed if Dehumidify with AC is set to "ON")		Use the and left and right arrows to select the maximum number of degrees of over cool.  Options are: 2,3,4,5	3

Tech Setup Steps	LCD Will Show	Adjustment Options	Default
<b>HUM Terminal</b> (Only displayed if humidify is set to "ON")		Options for how the HUM terminal energizes.  See chart below	1
<b>DHM Terminal</b> (Only displayed if dehumidify is set to "ON")		Options for how the DHM terminal energizes.  See chart below	1
<b>Dehumidify Relay</b> (Only displayed if Dehumidify is set to "ON")		You can configure the D terminal as Normally-Open or Normally-Closed.  NO = Normally Open NC = Normally Closed	NO



### HUM Terminal







OPTIONS	HUM terminal energizes when the ambient humidity is...
1	Below the humidity setpoint and heat or fan is energized.
2	Below the humidity setpoint and heat is energized.
3	Below the humidity setpoint. It will also energize the fan during a call for humidity.
4	Below the humidity setpoint.

### DHM Terminal

OPTIONS	DUM terminal energizes when the ambient humidity is...
1	Above the humidity setpoint and cool or fan is energized.
2	Above the humidity setpoint. It will also energize the fan during a call for dehumidify.
3	Above the humidity setpoint.
4	Above the humidity setpoint and the compressor is not running.

**Note:** When the dehumidify terminal is configured as normally-closed, the base module D terminal LED indicator will be lit when the relay is closed. When the thermostat calls for dehumidification, the D terminal LED indicator will turn off.

Tech Setup Steps	LCD Will Show	Adjustment Options	Default
<b>Unoccupied Heat Setting</b> (Only displayed if Occupancy Control is set to ON)		Full temperature range defined by setpoint limits.  First adjust the temperature using the + and - buttons.	70°
<b>Occupancy Sensitivity Setting</b> (Only displayed if Occupancy Control is set to ON)		High Sensitivity(3): This is the most sensitive setting and will detect very slight motions. This is the recommended setting because it will work well for nearly all applications, and will detect any movement.  Medium Sensitivity(2): This is the medium sensitive setting. This is less likely set off by pets.  Low Sensitivity(1): This is the least sensitive setting and can be used in areas of heavy traffic. Pets, small children, or people more than 20' from the sensor location are least likely to trigger the sensor.	2
<b>Local Ambient Enable</b> (Only displayed when using remote sensors)		ON - Maintains the Main Thermostat as a control point to be used in system averaging and occupancy control.  OF - Disables the local ambient temperature sensor removing the Main Thermostat from the system temperature.	ON

Tech Setup Steps	LCD Will Show	Adjustment Options	Default
<b>Freeze Protection</b>		Freeze protection provides some extra protection in case communication is lost between the thermostat (and remote sensors) and the Equipment module for any reason.  Note: A thermostat is not a safety device and the building will need additional precautions if left unattended for long periods of time.	OFF
<b>Device Name</b> (Only displayed when using remote sensors)		Press the + and - buttons to choose the name of this device from a selection of common room names.	
<b>Pairing</b>		Use this setting to pair your thermostat to the equipment module. Press and hold $\left[ \rightarrow \right]$ to join the network. This setting is only displayed when they have been unpaired for any reason.	P
<b>Exit Network</b>		Press and hold the $\left[ \rightarrow \right]$ to remove this device from the network.	UP
<b>Signal Strength</b>		Displays the strength of the wireless signal and network status.  NO - Disconnected LO - low signal strength HI - high signal strength	
<b>Network Info</b> (Only displayed when using remote sensors)		This setting shows information about the devices on your network. Press the $\left[ \rightarrow \right]$ and $\left[ \leftarrow \right]$ buttons to check the number of total devices, active indoor, and active outdoor remotes.	1



Tech Setup Steps	LCD Will Show	Adjustment Options	Default
<p><b>Occupancy Mode</b></p> <p>Two methods are available for using occupancy sensing to run the HVAC system providing flexibility to the homeowner based on their family and lifestyle.</p> <p>In both methods, once the Duration of Occupancy has expired for all remotes, the system will enter the Unoccupied Mode.</p> <p><b>NOTE:</b> Enabling either type of occupancy control will enable the occupancy sensor on all remote sensors as well (if applicable). When no remote sensors are connected, available options are "OFF" and "ON" (System Average).</p>	OF	<p>OF=OFF The occupancy sensor is off and the thermostat defaults to a traditional programmable or nonprogrammable thermostat.</p> <p>LS = Last Seen This option only allows one sensor to be in control at a time. Any time a person enters a new room, the entire system will prioritize that remote's settings to condition the entire home until another remote takes control or the Duration of Occupancy expires, entering Unoccupied Mode. This is a great solution for a household with a <b>single occupant</b>.</p> <p>SA = System Average This option allows multiple sensors to be in control at a time. If multiple remotes sense occupancy simultaneously, the system will average all remotes currently in Occupied Mode together. Each remote will drop off individually as its Duration of Occupancy expires. This is a great option for a household with <b>multiple occupants</b>.</p>	OFF
<p><b>Duration of Occupancy</b></p> <p>(Only displayed if Occupancy Control is set to "ON")</p> <p>When the occupancy sensor is turned on you have the ability to set how long the thermostat will go into occupancy mode everytime a person is sensed.</p>	8 OCC DURATION	<p>30 = 30 minutes, 1 = 1 hour, 2 = 2 hours, 3 = 3 hours, 4 = 4 hours, 5 = 5 hours, 6 = 6 hours, 7 = 7 hours, 8 = 8 hours, 9 = 9 hours, 10 = 10 hours, 11 = 11 hours, and 12 = 12 hours.</p>	8

Tech Setup Steps	LCD Will Show	Adjustment Options	Default
<p><b>Occupied Cool Setting</b></p> <p>(Only displayed if Occupancy Control is set to "ON")</p> <p>Set the cooling temperature that you would like the system to be while the space is occupied.</p>	75 CO OCC COOL	<p>Full temperature range defined by setpoint limits.</p> <p>Adjust the temperature using the + and - buttons.</p>	75°
<p><b>Occupied Heat Setting</b></p> <p>(Only displayed if Occupancy Control is set to "ON")</p> <p>Set the heating temperature that you would like the system to be while the space is occupied.</p>	70 HE OCC HEAT	<p>Full temperature range defined by setpoint limits.</p> <p>Adjust the temperature using the + and - buttons.</p>	70°
<p><b>Unoccupied Cool Setting</b></p> <p>(Only displayed if Occupancy Control is set to "ON")</p> <p>Set the cool temperature that you would like the system to be while the space is unoccupied.</p>	75 CO UNOCC COOL	<p>Full temperature range defined by setpoint limits.</p> <p>Adjust the temperature using the + and - buttons.</p>	75°

## Force Unoccupied Setting

To set your system to the unoccupied temperature immediately, press and hold the Light and Minus buttons on any indoor sensor or the main thermostat. Your thermostat or sensor should say "Unoccupied". The system will ignore occupancy changes for 5 minutes to allow you time to leave.

## Technician Setup

Tech Setup Steps	LCD Will Show	Adjustment Options	Default
<p><b>Humidity Pad Reminder</b></p> <p>Enables a reminder for the user to change the humidity pad.</p>	OFF HUM PAD 0	Use the $\square$ or $\square$ key to select OFF, 500, 1000, 1500, or 2000. These represent hours of heat operation.	OFF
<p><b>UV Lamp Reminder</b></p> <p>Enables a reminder for the user to change the UV light bulb.</p>	OFF UV LAMP 0	Use the $\square$ or $\square$ key to select OFF, 1 YR, 2 YR	OFF
<p><b>IAQ Cell Reminder</b></p> <p>Enables a reminder for the user to change the IAQ Cell after 25,000 hrs.</p>	OFF IAQ CELL 0	Use the $\square$ or $\square$ buttons to select OFF, or 25 (stands for 25,000 hours).	OFF
<p><b>FW Version</b></p> <p>This displays the current firmware version installed on the Main Thermostat. This can be helpful for troubleshooting if you ever need to call customer service.</p>	F7 T755WHO-001	N/A	

### Automatic Humidity Adjusting Index

When The Outdoor Temperature Is:	On 1	On 2
> +40°F	45%	50%
+30°F to 40°F	40%	45%
+20°F to 29°F	35%	40%
+10°F to 19°F	30%	35%
0°F to 9°F	25%	30%
-1°F to -10°F	20%	25%
-11°F to -20°F	15%	20%
<-20	10%	15%

## Setting The Humidity

### Setting The Humidity

Follow the steps below to change your target humidity setpoint.

Press the humidity button. Use the  $\square$  or  $\square$  button to select the target humidity setpoint. Press **Done** when completed.

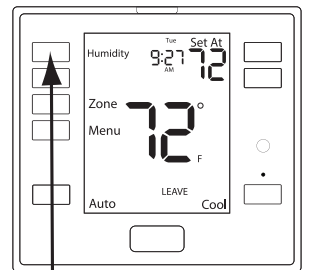

Humidity Key

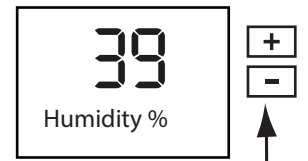

Target humidity setpoint keys

**Note:** Humidity is only energized during heat. Dehumidify is only energized during cool. HUMIDITY and DEHUMIDIFY each have their own target setpoints.

### Ambient Humidity Display

Ambient humidity will flash opposite the day and time, if the optional outdoor temperature sensor is installed the ambient outdoor temperature will also cycle in the display.



Ambient Humidity



Day & Time



Outdoor Temperature

### Increasing Humidity

The table on the right shows recommended indoor humidity levels in relation to outdoor temperatures during heating (adding humidity).

Consult your professional HVAC technician for recommended settings for your climate.

Outside Temperature (0°)	Recommended Relative Humidity
+20° and above	35% to 40%
+10°	30%
0°	25%
-10°	20%
-20°	15%

**Set Time (If using programming)**

Follow the steps below to set the day of the week and current time:

1. Press the **Menu** button.
2. Press **Set Time**.
3. Day of the week is flashing. Use the  or  key to select the current day of the week.
4. Press **Next**.
5. The current hour is flashing. Use the  or  key to select the current hour. When using 12-hour time, make sure the correct a.m. or p.m. choice is selected.
6. Press **Next**.
7. Minutes are now flashing. Use the  or  key to select current minutes.
8. Press **Done** when completed.

**Programming**

All our programmable thermostats are shipped with an energy saving default program. You can customize this default program by following the instructions in the **set program schedule section** starting on page 38.

Your thermostat can be programmed to have each day of the week programmed uniquely (7 days), all the weekdays the same with a separate program for Saturday and a separate program for Sunday (5+1+1), or non-programmable.

**A Note About Programmable Fan:**

The programmable fan feature will run the fan continuously during any time period it is programmed to be on. This is the best way to keep the air circulated and to eliminate hot and cold spots in your building.

**Default Programming**

Factory Default Program				
Day of the Week	Events	Time	Setpoint Temperature (HEAT)	Setpoint Temperature (COOL)
Weekday	Wake	6 AM	70°F (21°C)	78°F (26°C)
	Leave	8 AM	62°F (17°C)	85°F (29°C)
	Return	6 PM	70°F (21°C)	78°F (26°C)
	Sleep	10 PM	62°F (17°C)	82°F (28°C)
Saturday	Wake	6 AM	70°F (21°C)	78°F (26°C)
	Leave	8 AM	62°F (17°C)	85°F (29°C)
	Return	6 PM	70°F (21°C)	78°F (26°C)
	Sleep	10 PM	62°F (17°C)	82°F (28°C)
Sunday	Wake	6 AM	70°F (21°C)	78°F (26°C)
	Leave	8 AM	62°F (17°C)	85°F (29°C)
	Return	6 PM	70°F (21°C)	78°F (26°C)
	Sleep	10 PM	62°F (17°C)	82°F (28°C)

**Set Program Schedule For Four Time Periods**

**Saturday:**

1. Repeat steps 4 through 6 for the Saturday **WAKE** time period, **LEAVE** time period, **RETURN** time period, and for the Saturday **SLEEP** time period.

**Sunday:**

1. Repeat steps 4 through 6 for the Sunday **WAKE** time period, **LEAVE** time period, **RETURN** time period, and for the Sunday **SLEEP** time period.

**Temporary & Permanent Hold Feature**

**Temporary Hold:** The thermostat will display **HOLD** and  **Run Schedule** on the bottom of the screen when you press the or  key. If you do nothing, the temperature will remain at this setpoint temporarily for 4 hours. The program setpoint will then replace the temporary setpoint.

**Permanent Hold:** With a temporary hold set, If you press the **HOLD** key at the bottom of your screen, you will see **HOLD** appear next to the setpoint temperature in the display. The thermostat will now permanently stay at this setpoint and can be adjusted using the  or  keys.

**To Return To Program:** Press the **Run Schedule** key at the bottom of the screen to exit temporary and permanent holds.

**Filter Change Reminder**

If your installing contractor has configured the thermostat to remind you when the air filter needs changed, you will see **CHANGE FILTER** in the display when your air filter needs changed. The reminder will be shown in the display after your system has run long enough to require an air filter change.

To reset the timers for Prosync, user must hold the "Run Schedule" button (2nd button down on the left) on either the main screen, or the related timer tech settings.

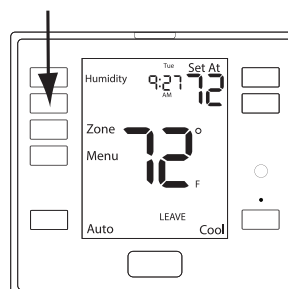

**Custom Programming** (Fill out before starting the process)

**Set Program Schedule For Four Time Periods** (WAKE, LEAVE, RETURN, SLEEP)

Custom Program				
Day of the Week	Events	Time	Setpoint Temperature (HEAT)	Setpoint Temperature (COOL)
Weekday	Wake			
	Leave			
	Return			
	Sleep			
Saturday	Wake			
	Leave			
	Return			
	Sleep			
Sunday	Wake			
	Leave			
	Return			
	Sleep			

If you intend to use additional Remote Sensors in addition to the Main Thermostat you must install, link and name all of the remotes in the system before you begin the scheduling process.

**To customize your 5+1+1 Program schedule, follow these steps:**

**Weekday:**

1. Select **HEAT** or **COOL** with the **System Key**.  
**Note:** You have to program heat and cool each separately.
2. Press the **MENU** button (If menu does not appear first, press **RUN SCHED**).
3. Press **SET SCHEDULE**. **Note:** Monday-Friday is displayed, and the **WAKE** icon is shown. You are now programming the **WAKE** time period for the weekday setting.
4. Time is flashing. Use the **+** or **-** key to make your time selection for the weekday **WAKE** time period.  
**Note:** If you want the fan to run continuously during this time period, select **ON** with the **FAN** key. **AUTO** will cycle the fan when there is a call for heat or cool. IAQ will cycle the fan intermittently based on the IAQ tech settings.
5. Press **Next**.
6. The setpoint temperature is flashing. Use the **+** or **-** key to make your setpoint selection for the weekday **WAKE** period.
7. At any point use the **ZONE** button to select the remote you want to be in control for that time period. If you want the system to average all remotes, select System Average.  
**Note:** This setting only applies if you are using multiple remote sensors.
8. Press Next.
9. Repeat steps 4 through 8 for the weekday **LEAVE** time period, for the weekday **RETURN** time period, and for the weekday **SLEEP** time period.

**Specifications**

**Specifications**

The display range of temperature ...	41°F to 95°F (5°C to 35°C)
The control range of temperature....	44°F to 90°F (7°C to 32°C)
Load Rating.....	1 amp per terminal, 1.5 amp maximum all terminals combined
Swing (cycle rate or differential) .....	Heating is adjustable from 0.2° to 2.0° Cooling is adjustable from 0.2° to 2.0°
Power source .....	18 to 30 VAC, NEC Class II, 50/60 Hz for hardwire Battery power from 2 AA Alkaline batteries
Operating ambient .....	32°F to +105°F (0°C to +41°C)
Operating humidity .....	90% non-condensing maximum
Dimensions of thermostat .....	4.7" W x 4.3" H x 1.1" D
Frequency .....	916 MHz
Base module	
Load rating .....	1 amp per terminal, 1.5 amp maximum all terminals combined
Power source .....	18 to 30 VAC, NEC class II, 50/60 Hz

**Warranty Information**

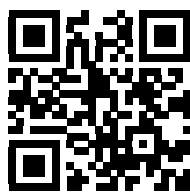

**Warranty Registration**

Your new thermostat has a 5 year limited warranty. You must register your thermostat within 60 days of installation. Without this registration the warranty period will begin on date of manufacture. For warranty issues please contact the HVAC professional that installed this product. Please register your new thermostat online.

Please Register Your Thermostat Here

[www.vivecomfort.com/warranty](http://www.vivecomfort.com/warranty)

**Specifications**

This device complies with part 15 of the FCC Rules. Operation is subject to the following two conditions: (1) This device may not cause harmful interference, and (2) this device must accept any interference received, including interference that may cause undesired operation.

Any changes or modifications not expressly approved by the party responsible for compliance could void the user's authority to operate this equipment.

Note: This equipment has been tested and found to comply with the limits for a Class B digital device, pursuant to part 15 of the FCC Rules. These limits are designed to provide reasonable protection against harmful interference in a residential installation. This equipment generates, uses and can radiate radio frequency energy and, if not installed and used in accordance with the instructions, may cause harmful interference to radio communications. However, there is no guarantee that interference will not occur in a installation. If this equipment does cause harmful interference to radio or television reception, which can be determined by turning the equipment off and on, the user is encouraged to try to correct the interference by one or more of the following measures:

- Reorient or relocate the receiving antenna.
- Increase the separation between the equipment and receiver.
- Connect the equipment into an outlet on a circuit different from that to which the receiver is connected.
- Consult the dealer or an experienced radio/TV technician for help.

FCC RF Exposure Statement

The device shall be used in such a manner that the potential for human contact normal operation is minimized. This equipment complies with FCC radiation exposure limits set forth for an uncontrolled environment. This equipment should be installed and operated with a minimum distance of 20cm between the radiator and your body. This device and its antenna(s) must not be co-located or operating in conjunction with any other antenna or transmitter.